



Volvo Trucks. Driving Progress

# VOLVO FH16

PRODUCT GUIDE - EURO 3-5





## The world's most powerful truck is now even stronger.

They say that you shouldn't change a winning concept. Yet, that's exactly what we have done with the Volvo FH16. We have taken the world's most powerful truck, and made it capable of taking tougher and more demanding jobs than ever before.

Everything from the comfortable FH16 cab and the Volvo Dynamic Steering to the powerful 16 litre engine and new I-Shift with crawler gears are developed to take productivity and driving comfort to new heights. So why settle for less?



## OVERVIEW

# A closer look at the Volvo FH16.



42

### DRIVER SUPPORT SYSTEMS

The forefront of safety is Volvo's home ground. Our advanced driver support systems efficiently helps the driver avoid accidents. [Learn more on page 42.](#)

20

### DRIVER INTERFACE

The instrument cluster and the new integrated system for services and infotainment offers an industry leading driver interface. [Learn more on page 20.](#)

12

### CAB EXTERIOR

The Volvo FH16 features exterior design elements showing that you are driving the world's most powerful truck. [Learn more on page 12.](#)

24

### VOLVO DIESEL ENGINES

Fuel-efficient and torque-strong 16-litre engines. Pick the perfect choice for your assignments. [Learn more on page 24.](#)

32



### LOW SLEEPER CAB

The extra low cab is ideal for construction, mining or timber transports. [Learn more on page 32.](#)

40

### HEADLIGHTS

Dynamic headlights, static cornering lights, improved main beams and more. [Learn more on page 40.](#)

26

### HEAVY DUTY BUMPER

The optional heavy-duty bumper will protect your new truck from scratches, dents and broken headlights in both rough terrain and busy traffic. [Learn more on page 26.](#)

18

### HANDLING

We've designed every part of the truck to contribute to stable and precise handling. [Learn more on page 18.](#)

6

### VOLVO DYNAMIC STEERING

The biggest invention since power steering lets you enjoy effortless manoeuvring with extreme precision. [Learn more on page 6.](#)

22

### I-SEE\*

A cruise control that plans ahead – our latest addition to the intelligent I-Shift software is revolutionary. And it saves up to 5% fuel. [Learn more on page 22.](#)

### UPTIME

The Telematics Gateway puts Volvo FH16 in touch with the workshop from anywhere. [Learn more on page 38.](#)

38

14

### CAB INTERIOR

The cabs are more spacious than ever and contain lots of features. [Learn more on pages 14-17.](#)

34

### BODYBUILDING INTERFACE

The shorter time at the body-builder, the more time and money there is to save. There are a lot of clever chassis features to help you. [Learn more on page 34.](#)

46

### ACCESSORIES

Tailor your truck for your assignments and your needs – and make it more efficient for the work you do. [Learn more on page 46.](#)

30

### TANDEM AXLE LIFT

Only use the extra drive axle on your tandem drive when you need it. Tandem Axle Lift reduces your fuel consumption, tightens your turning radius and improves your traction. [Learn more on page 30.](#)

28

### REAR AIR SUSPENSION

Experience the air-suspended rear-wheel installation. One could say it's an earth-quaking development and its low weight means more payload. [Learn more on page 28.](#)

VIEW SELECTED  
SPECS ON PAGES  
44-45

\*I-See is only available on Euro 5 and Euro 6 markets.

## VOLVO DYNAMIC STEERING

# Responding to your slightest command.

## And nothing else.

What has been called the biggest thing since power steering is now available in a series-production truck, both with single and dual front axles. Volvo Dynamic Steering is based on a patented concept, and will completely change the way you drive. Try it, and you'll never want to go back to a regular truck. Even your car will pale in comparison.



### How it works.

Volvo Dynamic Steering consists of an electric motor, connected to the steering gear. By receiving input from several sensors, the ECU (Electrical Control Unit) can determine where the truck is going as well as what the driver's intentions are.

The motor is controlled 2000 times every second, using a principle called "torque overlay", to correct unintentional steering movements and to provide extra torque when needed. Altogether creating a perfect and consistent steering feel, regardless of load and tyres.



**EFFORTLESS**  
Volvo Dynamic Steering decreases the steering effort by up to 85%.



### At high speeds: Let nothing set you off course.

Driving straight isn't as easy as one would think. In fact, you often have to compensate for kicks from road ruts, pot holes and road markings. Or correct your course after braking on a mixed-friction surface. Yes, sometimes even side winds can disturb your ride.

Volvo Dynamic Steering changes this completely. Just loosen your grip on the wheel, concentrate on the traffic and be sure the truck won't change direction until you want it to.



### At low speeds: Steer with one finger and save your back.

This is where Volvo Dynamic Steering really will change your day. And your future. Because you no longer need to strain your muscles to manoeuvre the truck at low speeds. Volvo Dynamic Steering provides you with all the steering force you need. You can literally steer the truck with one finger. This not only gives you complete control of the vehicle but also practically eliminates the strain on your neck and shoulders.



### When reversing: Perfect control without strain.

Reversing with a fully laden truck is one of the most challenging and trying aspects of the job. Especially where you need to focus every bit of your attention on the surroundings. Not so with Volvo Dynamic Steering. You now reverse with perfect precision – almost without effort. And as soon as you let go of the wheel, it automatically returns to neutral, reducing the strain even further.

Furthermore, if you need to reverse long distances, here's something unique. The course stability is so great that you can reverse a truck and trailer more than a hundred metres without drifting off course.

# Forget the gearbox. Just drive.

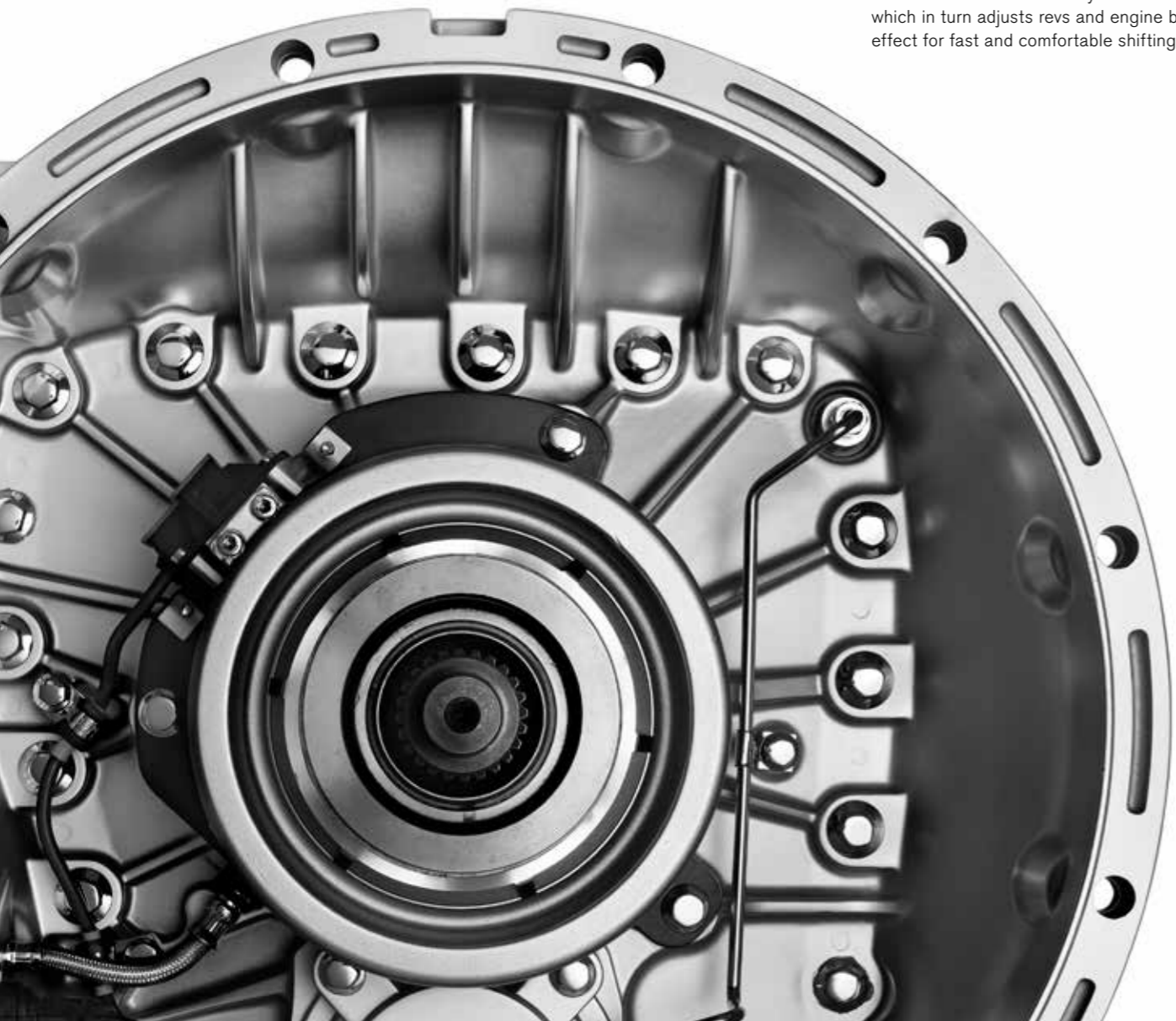

### How it works.

It may seem strange. Beneath the surface of I-Shift, the archetype of modern transmissions, hides an old-school unsynchronised manual gearbox. (Hence the compact design and low internal losses.) But of course there's much more to I-Shift than that. The secret lies in the intelligent electronic control unit. It's responsible for controlling the pneumatic system that handles the clutch and shifts. By constantly receiving information about vehicle speed, acceleration, weight, road grade, torque demand and more, it can carry out every shift with extreme precision. It also communicates closely with the engine, which in turn adjusts revs and engine brake effect for fast and comfortable shifting.



### Eases your mind. And lets your left foot rest.

Driving I-Shift is a real pleasure. Without the clutch pedal, you can safely sit back and concentrate on the other two. I-Shift uses its built-in intelligence to quickly and automatically choose the right gear at all times. And the software provides shifting skills that are impossible for even the best of drivers to match. Still, if you want to get more involved, you can. The buttons on the shift selector allows you to step in and shift gear manually.



### An unexpected option. I-Shift without gearstick.

If you're used to driving with I-Shift, you've probably noticed that you don't actually use the shift selector that much. That's why the Volvo FH16 offers you the option of getting rid of it altogether and have it replaced with four switches on the dashboard (still within easy reach, of course). Freeing that precious space makes it a little bit easier to move around in the cab.

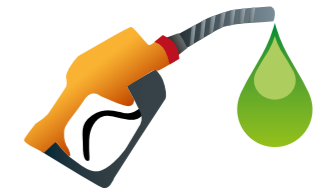

### Let I-Shift save you fuel. The money will roll right in.

I-Shift is designed to save fuel. First of all, the internal energy losses are low – actually lower than on manual gearboxes. But it's the electronics that really make the difference. When driving in Economy mode, every gearchange is timed precisely, to let the engine work at its most efficient rpm range. And then there's I-Roll. It's a unique feature used when driving downhill, automatically disengaging the engine to make use of the truck's momentum instead of fuel. The result? Up to 2% lower fuel consumption.

Not enough for you? Add I-See\* to save more. Learn more on [page 22](#).

### How would you like your I-Shift?

The software makes it possible to tailor I-Shift to your driving conditions. Choose from four add-on packages: Long Haul (with or without I-See\*) for efficient highway driving, Distribution with smart functions for close-quarter manoeuvring, Construction that handles tougher road conditions, and Heavy Duty Transport (with or without I-See\*), optimising I-Shift for gross combination weights above 85 tonnes. 🚚



### When things get really tough the I-Shift for heavy duty makes it easier.

If you're into heavy assignments in very hilly terrain you can count yourself lucky. Now there's an I-Shift for you, too, perfectly suited to your specific needs, offering you all the comfort and fuel economy of the I-Shift gearbox.

We've developed a clutch with a larger diameter on the damper mechanism, and new clutch and gear control software for high torque. The result is an I-Shift gearbox perfectly adapted for timber and construction assignments as well as other heavy applications. And if this shouldn't be enough, you should check out the I-Shift with crawler gears. Learn more on [page 10](#).

🚚 Also available as an accessory. \*I-See is only available on Euro 5 and Euro 6 markets.

# The fastest way to productivity? Slow down.

I-Shift just got even more versatile and easy to drive. The automated gearbox is now available with the choice of one or two crawler gears, plus the additional option of extra reverse gears.



**Start wherever you want.**  
If you transport heavy loads, you know that starting from a standstill can sometimes be difficult, especially in hilly terrain or poor road conditions. Ultimately, you may have to unload the cargo or even request towing, which has devastating effects on your uptime and productivity. Equip your FH16 with crawler gears and this will be a worry of the past. Your startability is dramatically improved, and the strain on the clutch is reduced by up to 75 percent, saving you from unnecessary repairs.



**Crawl slow, run lean.**  
Can crawler gears really help boost your fuel economy? Sure. Because previously, you often had to be willing to sacrifice fuel economy for startability. But thanks to the crawler gears, we can now specify your truck with a faster rear axle ratio, allowing you to stay on cruising speed at much lower revs when you're driving on decent roads. This lowers your fuel consumption by up to a couple of percent.



**Say yes to extreme conditions.**  
Crawler gears adds to the versatility of the truck, letting you use the same truck for a host of different driving conditions and assignments. Drive both on-road and off-road? Need to transport extreme loads up to 325 tonnes? Work at high altitudes? Special low-speed applications? No problem.



**Perfect control in any direction.**  
Low-speed manoeuvring is one of the most challenging aspects of the job. Thanks to a transmission ratio of up to 32:1 (and up to 37:1 in reverse), the crawler gears let you drive slower than ever – half the speed compared to a regular I-Shift. You always have total control, making it easy to manoeuvre with high precision even in poor conditions.

**SLIM GEARS**  
The crawler gear module only adds 120 mm to the length and 48 kg to the weight of I-Shift.

## CAB EXTERIOR

# How to recognise the world's most powerful truck.

There are both distinct and subtle signs that you are driving a truck that's something extra. The Volvo FH16 has a number of unique design features that reflect its power and capability. Take a closer look.

### The new black.

The FH16 colour is dark. Very dark. But under this surface, there's an intriguing tone hiding. We call it Mystic Fjord. You have to see it.



### Accentuating shades.

Outside the cab wall, providing Volvo FH16 with a unique appearance, is a tinted glass pane. Not for looking out. But for looking at.



### Imposing figures.

A little sign that gives a hint about the power available.



### Attention to details.

Subtle details make all the difference. Especially when in shiny chrome. This is what makes the front step, grille trim, door handles and Volvo iron mark stand out.



### The grille of a champion.

The satin dark-silver grille makes a distinct impression on any road. The mirrors and sun visor share the same premium look.



### Standing out from the crowd.

The side mirrors' slim design adds to the cab's distinctive profile. Not only do they offer excellent visibility and aerodynamics – the silver coloured housings hint that this truck is something less ordinary.



### Light in the dark.

The characteristically V-shaped positioning lights are matched by a unique dark Volvo FH16 colour scheme that hints that this is not just any truck.



CAB INTERIOR

# Globetrotter reinvented.



STAY IN BED

PLENTRY OF ROOM FOR STUFF

WIDE AND COMFORTABLE BED FOR SLEEP OR REST

PLENTRY OF SPACE BETWEEN WHEEL AND BELLY



THE SKY IS THE LIMIT

PREPARED FOR A 19" TV

BACK-SAVING STEERING WHEEL ADJUSTMENT WITH NECK-TILT

EVERYTHING AT YOUR FINGERTIPS

BUILT-IN PARKING COOLER

MORE FEATURES OVERLEAF



## CAB INTERIOR

# Packed with features. And space.



### Built-in parking cooler.

Superior cooling capacity, without compromising in-cab space or aerodynamics. I-ParkCool is the integrated parking cooler that lets you sleep well at night, and save fuel during the day.



### Modern and ergonomic dashboard.

The gently curved dash not only looks appealing. It's designed for an ergonomic and comfortable driving position with all buttons, instruments and storages within easy reach.



### Plenty of space between wheel and belly.

Don't get stuck behind the wheel. The seat adjustment range is of world class – a whole 24 cm from front to back. That means drivers of all sizes sit comfortably.

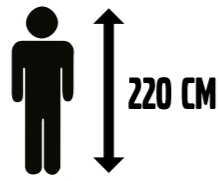

### Full standing height.

Unless you're a professional basketball player, here's plenty of headroom. 220 cm in the largest cab, Globetrotter XL. It's not only practical, it also gives a spacious feel.

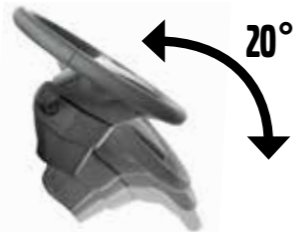

### Back-saving steering wheel adjustment with neck-tilt.

The fully adjustable steering wheel with a 20° neck-tilt function makes for comfortable driving. Folds away easily when you enter or exit the cab. Conveniently controlled by a foot pedal.



### All at your thumb tips.

Buttons for cruise control, audio, phone and what's in the information displays, allow you to keep a tight grip on the wheel.



### First class.

The interior features unique door panels, wall panels, chromed decor trim, curtains, bunk upholstery and additional door lights. All together, they create a luxurious mood inside the cab.



### Everything at your fingertips.

Easy-to-use navigation and fleet management. Improved communication and increased safety. Enhanced quality audio entertainment. Volvo's integrated system for services and infotainment brings together everything you need on the 7-inch touch screen. Learn more on [page 20](#).

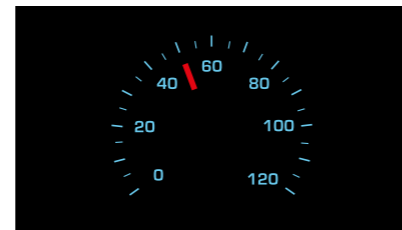

### Night mode.

A standard safety feature that allows you to turn off all backlights in the instrument cluster, except for the speedometer. You won't be distracted by irrelevant lights. This makes it safer to drive at night – or to connect the trailer when visibility is poor. However, if a warning alert occurs, it will show up on the panel.



### Electronic remote key.

It's more than a key. Lock or unlock from a distance. Turn on the lights to approach the cab safely. And if you're feeling threatened, just push the panic button to blast the horn. 🚗



### Sound system.

The sound system includes everything you need to enhance your in-cab experience. Access to streaming media services such as Spotify, Deezer and TuneIn. DAB/DAB+ (Digital Audio Broadcasting) as option. 🚗



### ECC with air-quality sensors.

Electronic climate control with top-notch air vents and a multitude of sensors and filters, processing the air before it fills your lungs. The result is unprecedented air quality, improved defrosting and a draft-free environment.



### Clean water anywhere.

If you want fresh water, you don't have to go far. The exterior compartment holds a 7-litre tank equipped with a tap. 🚗



### Prepared for a 19" TV.

Volvo FH16 can be factory-prepared for mounting a TV set – complete with brackets, antenna and outlets for power and TV signal, as well as an aux input, connecting the TV to the audio system. 🚗



### Plenty of room for stuff.

You can have everything in place. The spacious front, under-bunk, rear and exterior storages can be tailored to your needs, and are accompanied by plenty of convenient compartments for smaller items.



### Wide and comfortable bed for sleep or rest.

No need to sleep tight. The lower bunk is wide and offers first class comfort. There's even a really wide retractable bed. And the head part can be inclined up to 55°.



### The sky is the limit.

Adding to the spacious feeling, the tinted glass sky window is the finest emergency exit you'll ever see. It has sun blinds and mosquito net, and can be fitted with an electrically controlled hatch.\*



### A comfortable ride.

All the different options of cab suspension. The improved steering-gear position. The well designed front-end geometry. The smooth engine mounting. And more. We've taken many steps to create world-class comfort and driving pleasure.



### Advanced interior lighting.

13 energy-efficient and powerful light sources make for fantastic in-cab lighting. All are easily controlled in three preset steps or with the dimmer. When driving in the dark – switch to the red lights to preserve your night vision.



### Stay in bed.

The advanced sleeper panel lets you control the interior lights, alarm clock, parking heater, parking cooler, audio system, windows, roof hatch and locks. All without leaving the bunk.



### Electric parking brake.

The electrically controlled parking brake is handled with an easy-access dashboard switch. Automatically engages at key-off, and – with a little help from EBS – automatically releases when taking off.



### Room for alcoholock.

Alcohol doesn't belong in traffic. That's why the alcoholock does. Factory fit it to your Volvo FH16, and send a clear message to your customers how seriously you take road safety. 🚗

## HANDLING

# Handles like no other truck.

Volvo FH16 has handling characteristics above the ordinary. We've virtually designed every part of the truck to contribute to the stable feel and precise steering. You really have to experience the result for yourself. But if you want to know why it performs so well, here's the quick-list:



### **The rear suspension stabiliser bar.**

New Volvo-patented design with stabilisers in front of the axle eliminates rear-chassis torsion. This provides a very stable course and therefore a comfortable, safe and rapid ride. The re-designed stable bar also makes it possible to specify the truck with short rear overhang, great for construction applications.

### **The engine suspension.**

Improved front mounting prevents vibrations from spreading through the truck, to provide an even more comfortable ride.

### **The front suspension.**

Enhanced geometry on leaf suspensions. Improved design on all air suspensions. Here is one of the major reasons why the truck behaves very stable and safe on the road. Take a drive yourself and feel the comfort.

### **The rear cab suspension.**

The cab must be softly sprung in order to be comfortable to ride in. But it must not lurch because this would result in gravity shifting of the vehicle, which would affect the handling characteristics adversely. We solved it with a sophisticated suspension. Vertical springs with increased spread promote stability and driving comfort.

### **Volvo Dynamic Steering**

Fast and precise torque overlay by electronic motor and unique, patented concept. Resulting in improved directional stability, low shunting steering forces and suppression of road disturbances.



## DRIVER INTERFACE

# A world of infotainment at your fingertips.

Easy navigation and improved communication. More efficient fleet management. Volvo Trucks' integrated system for services and infotainment brings it all together on an integrated touch screen – for a safer more comfortable driving experience.

It's easy-to-use and it can be operated directly on the screen, via voice command, and by steering wheel buttons. All the information is where you need it. In one place. Stay connected.



### Information is central.

A quick glance at the centre of the speedometer is enough to get key information about gear, I-Shift mode, (adaptive) cruise control, auxiliary brakes and tachometer.

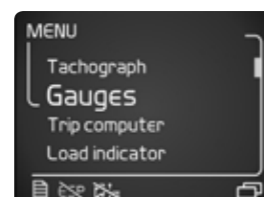

### Driver Information Display.

Convenient 4-inch display showing a lot of additional information. Choose what you want to see, using the steering wheel buttons. The customised view allows you to select up to three favourites such as different gauges, driver alert support or load indicator. If an error should occur, the message tells you in clear text what's wrong. No risk of misunderstanding. Available as monochrome or colour display.



### Secondary Information Display.

It gives you access to the integrated system for services and infotainment. Navigation, fleet management, communication, increased safety and quality audio entertainment – it's all there on a 7-inch touch screen. 📱

### BUILT-IN GPS NAVIGATOR

The Volvo FH16 has a fully integrated navigator. Knowing the truck's specification, it can use map data to help you choose a route that suits your axle load and vehicle height. It also integrates nicely with Dynafleet OnBoard, so you can receive exact GPS destinations from the office. 📱

### DYNAFLEET ONBOARD

No separate display needed. All information from Volvo's transport management system is integrated in the SID-High. 📱

### SOUND SYSTEM

The sound system includes everything you need to enhance your in-cab experience. Access to streaming media services such as Spotify, Deezer and Tuneln. DAB/DAB+ as option. You can connect via USB, AUX or wireless via your smart phone. 📱

### PHONE

Two phones can be connected via Bluetooth at the same time so you can browse your phone book, talk into the built-in microphone and listen through the speakers.



# Now every road is worth remembering.



**Lower fuel consumption by 5%. Just activate the cruise control.**  
Combine I-Shift and the GPS with an intelligent cruise control, and you get I-See. It's a unique system that learns the topography of the road and stores it in a central database. When you're driving, it automatically uses its knowledge to save fuel – up to 5% during a driving cycle (when I-Cruise is engaged the whole time).



**Wherever you are, you can get help from the cloud.**  
I-See doesn't rely on maps. Since reality tends to be more accurate, it memorises the actual slopes instead. And you don't have to have travelled the route before to save fuel. I-See stores all hills in a database free for all other trucks to use. As long as someone has travelled the route before, I-See can download the data and start saving fuel immediately.

**BEFORE THE UPHILLS: TAKING OFF.**

When I-See knows an uphill is coming, it lets the speed increase, approaching the upper speed limit, to gain momentum. The truck can stay longer in a higher gear.

**ON THE UPHILLS: KEEPING FROM DOWNSHIFTING.**

When climbing, I-See uses its stored knowledge to avoid unnecessary downshifts towards the top. You approach the crest smoothly without wasting fuel in a lower gear.

**ON THE CRESTS: STAYING CALM.**

When approaching a downhill, I-See keeps the truck from accelerating unnecessarily.

**BEFORE THE DOWNHILL: ROLLING ON.**

Just before the slope, the driveline temporarily disengages, allowing the truck to roll. This saves energy, and minimises the need for braking.

**ON THE DOWNHILLS: BRAKING IN TIME.**

I-See knows when the slope ends. Thus, when gaining speed downhill, it can apply the engine brake gently in time – instead of abruptly at the end – to prepare for the upcoming topography.

**IN THE HOLLOWES: SOME EXTRA SCHWUNG.**

When a downhill is followed by an immediate uphill, I-See really comes to its right. It lets the truck roll, gaining speed and momentum to climb uphill with less effort.

**I-CRUISE**

One part of I-See is called I-Cruise. It's the intelligent cruise control that adjusts the speed for minimum fuel consumption. You can order it separately, and save up to 2% fuel.

# Massive fuel-efficient power.

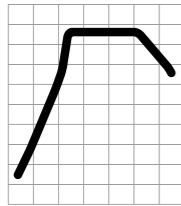

**The Volvo torque curve. You'll feel it in the pedal.**

Excellent torque at low revs. An extremely wide max torque range. Peak torque meets peak power. Volvo's leadership in diesel-engine technology is clearly visible once you start comparing engine curves. You'll experience fast acceleration, excellent pulling power, comfortable low-speed handling and, not least, a fuel-efficient and pleasurable ride at cruising speed.



**Pick the best power rating.**

The engine range for Volvo FH16 comprises different power ratings that makes it easy to pick the one that suits your transport assignment.



**Fuel-efficiency built-in.**

The D16 engine's massive power and wide max torque range means that the FH16 can carry out really heavy assignments while keeping the fuel consumption down. Your bottom line will reap the benefits. So will the environment.



**VEB+. Up to 578 hp of braking power.**

Minimise wear on the brake pads. Volvo's patented engine brake absorbs up to an impressive 425 kW (578 hp) on the D16, thanks to the unique camshaft design with four rocker arms. Integrated with I-Shift and the cruise control, it lets you maintain a high average speed without compromising safety or fuel economy. And in most cases, no retarder will be needed.

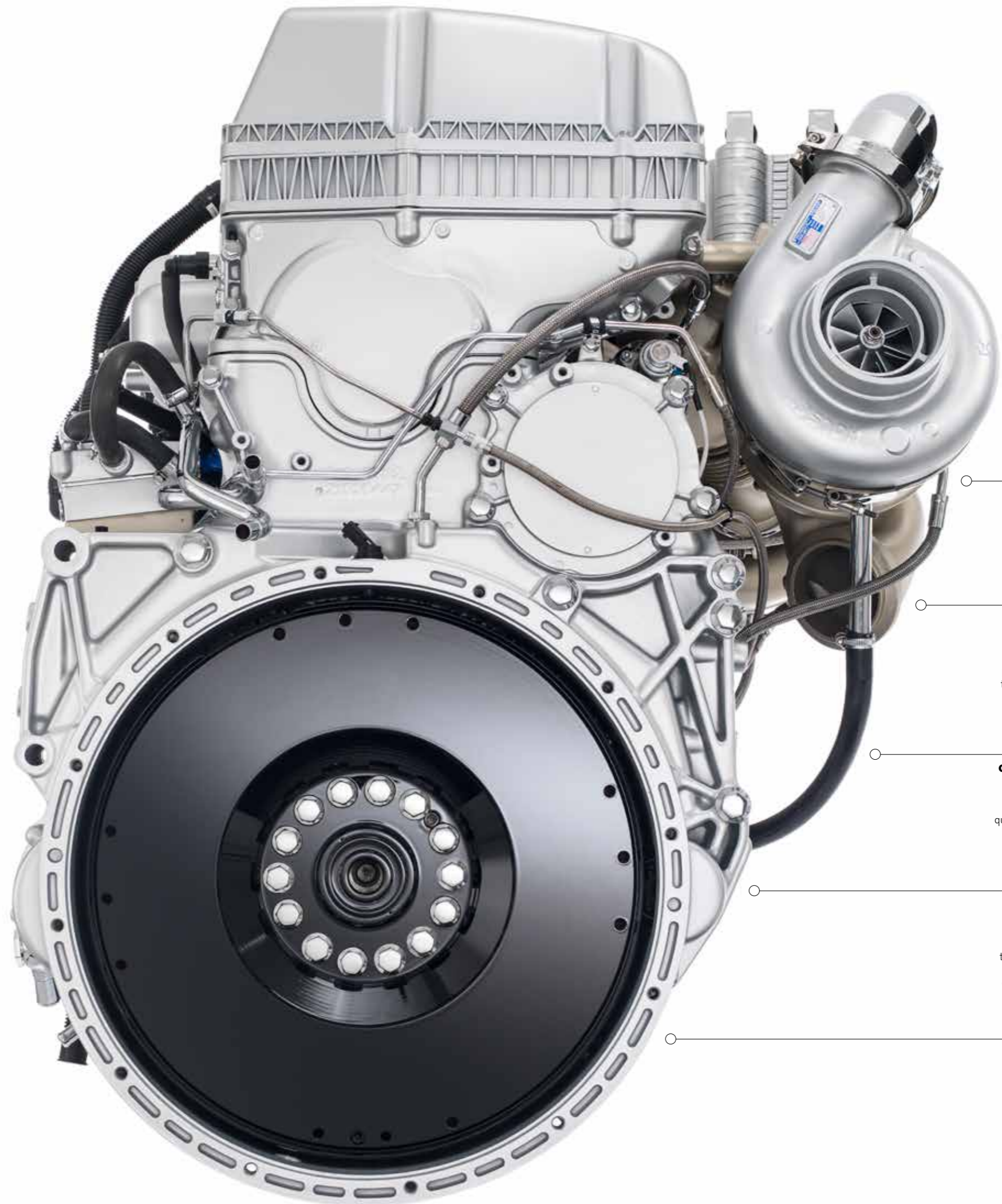

**INLINE SIX**  
6 cylinders. 7 bearings to distribute the forces. Reliability never goes out of style.

**EMS-CONTROLLED UNIT INJECTORS**  
Up to 2400 bar of injection pressure with perfect timing, thanks to the Engine Management System (EMS).

**CLOSED CRANKCASE VENTILATION**  
Recycles the crankcase gases, for improved air quality around the vehicle.

**REAR TIMING MECHANISM**  
A compact and weight-saving design, powering the air compressor along with the power steering, oil, and fuel feed pumps.

**HYDRAULIC PUMPS WITH CLUTCHES**  
The range of engine-mounted hydraulic pumps includes two declutchable ones.

## HEAVY DUTY BUMPER

# How can a bumper affect your uptime?

It doesn't matter how skilled you are. Whether you are driving demanding long haul routes, challenging construction sites or fearsome logging tracks – it's easy to bump into something and damage the truck. Thus, the headlights must be protected and well anchored. Rough surfaces and rocks must not damage the oil pan. The bumpers must withstand rough treatment. And if something does happen, you shouldn't need to bring the truck to the workshop. Just keep on running as if nothing happened. Because uptime is essential.



### Robust design.

Similar to the Volvo FMX's bumper, the heavy duty bumper on the Volvo FH16 is made of 3 mm high-grade steel. It's also partly covered by a thick polypropylene coating making it less liable to scratches. Super strong and robustly designed, it'll protect your truck from scratches, dents and broken headlights on any terrain.



### Protection at its best.

The complete lower front is made as a box construction. Every part of it interacts, making the construction very sturdy, but at the same time resilient in a collision with a car.

We have mistreated this truck in our tests, more than you ever will do. And we are now convinced that this is the sturdiest front in the industry.

### The skid plate.

This protecting guard plate under the engine is really worth its name. It is 3 mm thick and it doesn't only protect the engine sump but the hoses and cooler too. Everything that is perishable when driving off road is protected, even when you reverse.

The skid plate has another advantage too; if you drive in a very dusty environment the plate reduces dust vortices under the truck.

## REAR AIR SUSPENSION

# There's a right solution for every job.

Compared to traditional leaf suspension, air suspension offers many benefits. It provides a smoother ride, regardless of the road conditions – saving the truck, the cargo and, most importantly, the driver from additional wear. Different jobs require different solutions and since the FH16 can cover everything from fast and efficient long haul transports to tough construction work, we have solutions that optimise them all.

Our rear air suspension that is especially developed for construction trucks, offers high ground clearance (at least 300 mm) and is tough enough to handle rough terrain. And for long haul transports we now introduce an even lighter rear air suspension alternative as well as a lighter more compact pusher axle.



### Weight saving rear axle installation for long haul.\*

If weight is critical to your transport assignments, the new optimised air suspended rear axle installation, GRAS-G4, reduces the vehicle weight with 90 kg while still offering an 11.7 tonne axle load capacity. It comes in a wide range of axle ratios and is an excellent choice for 4x2 tractors in long haul transports up to 44 tonnes combination weight.



### Light weight pusher axle.\*

A weight optimised 6x2 pusher installation reduces the truck's kerb weight with up to 500 kg, meaning a potential for increased payload. The new installation is more compact and makes room for bigger fuel tanks and other equipment on the chassis.

### STABILISERS IN BOGIE CENTRE

The position of the stabiliser bar results in less torsion forces on the chassis and better roll and tipping stability. It also contributes to the high ground clearance.

### AIR BELLOWS MOUNTED ABOVE THE AXLE

The air bellows are well protected and their positions contribute to the high ground clearance. As do all other components.

### PROTECTED BRAKES

Don't worry. No parts of the braking system stick out beneath the rear axle. That's why you can be sure that the truck can handle all obstacles.

### AIR SUSPENSION

Air suspension provides outstanding driving comfort and makes it possible to vary the ground clearance. No parts of the suspension lay outside the rear tire envelope. This makes it easier to adapt the chassis for applications such as asphalt layers or tippers.

### BETTER TRACTION AND HIGHER AVERAGE SPEED

Optimised rear-axle pressure on every axle means better traction, thanks to the air suspension. The driver can adjust axle load distribution for better traction if needed. Air suspension gives less vibration into the truck and you will get an improved driving comfort, especially when unloaded. This will also contribute to a higher average speed.



### HIGH BOGIE LOAD

Tandem: 26 tonnes.  
Tridem: 36 tonnes.

### HIGH GROUND CLEARANCE

300 mm under the stabilisers.  
335 mm under the differential.



## TANDEM AXLE LIFT

# Lower fuel consumption and turning radius?

## Just raise the drive axle.

Tandem Axle Lift is a unique feature, allowing your 6x4 or 8x4 to combine the traction and load capacity of four-wheel-drive with the driveability and efficiency of two-wheel-drive – all in one vehicle.



### Up to 4% lower fuel consumption when unladen.

Because of the added friction and rolling resistance, drive axles usually consume quite a lot of fuel – all of the time. Not so with Tandem Axle Lift. By disengaging and raising the drive axle when it isn't needed, you can reduce your fuel consumption by as much as up to 4% when unladen. That adds up to a lot of money in the long run.

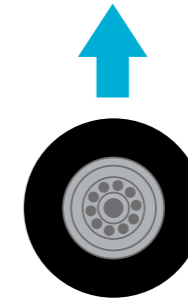

### Get a grip.

As long as the axle load limits allow, the axle can be raised to shift all the weight to one drive axle, for better grip and traction. It can even be performed while driving at low speeds.



### Enjoy better turning radius.

Tandem Axle Lift can effectively convert a 6x4 to a 4x2, or an 8x4 to a 6x2. Just like when raising a dead axle, this significantly improves the manoeuvrability of the truck by shortening the turning radius. In fact, a 6x4 with a wheelbase of 4.6 metres, for example, can reduce its turning radius by over a metre.

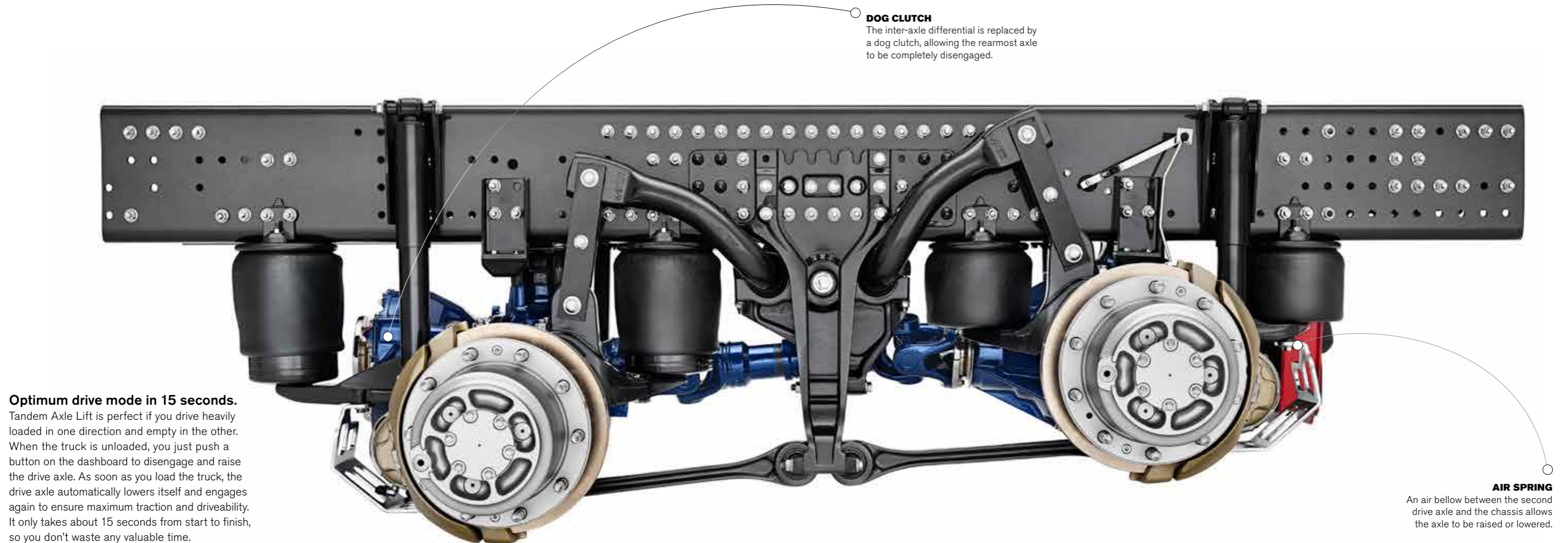

### DOG CLUTCH

The inter-axle differential is replaced by a dog clutch, allowing the rearmost axle to be completely disengaged.

### Optimum drive mode in 15 seconds.

Tandem Axle Lift is perfect if you drive heavily loaded in one direction and empty in the other. When the truck is unloaded, you just push a button on the dashboard to disengage and raise the drive axle. As soon as you load the truck, the drive axle automatically lowers itself and engages again to ensure maximum traction and driveability. It only takes about 15 seconds from start to finish, so you don't waste any valuable time.

### AIR SPRING

An air bellows between the second drive axle and the chassis allows the axle to be raised or lowered.



## LOW SLEEPER CAB

# The lower cab is the main highlight.

When the ceiling is low on your routes. When the timber crane is resting on the roof. When the road and the load require a powerful transmission. That's when you appreciate a Volvo FH16 with an extra low cab.



### Low ceiling, but still free space above the roof.

If you are into mining transports then you probably know that the corridors normally have a clear height of 3.4 metres. That means that with the low cab of just over three metres you go free. For trucks used in mining, you can choose the low cab with the additional protective roof. It does not add more than a minimal 15 mm in height.



### A clean cab roof.

If you want to take advantage of the low cab height, then you don't want anything sticking up from the roof. Fortunately, the antennas on the Volvo FH16 can all be moved out of the way. The FM and GSM/GPS antennas can be moved to the right-hand cab side and the CB and toll collect antennas to the left-hand side.



### If you're into the woods.

Do you transport timber? Perhaps your equipment includes a crane that has to rest on the cab roof. The low sleeper cab is developed with this in mind. We've even lowered the cab suspension by 20 mm, put 22.5" tyres and a low front axle on it to make a perfect solution when you need to fit equipment on the cab roof and stay within the European 4-metre limit.



### Driving comfort. A matter of height.

The air suspension system ECS4 lets you choose from three customisable driving heights, to optimise ground clearance or aerodynamics, improving ride comfort even further.

The total height of a Low Sleeper Cab Volvo FH16 can be specified to less than 3.2 metres high.

**< 3200 MM**

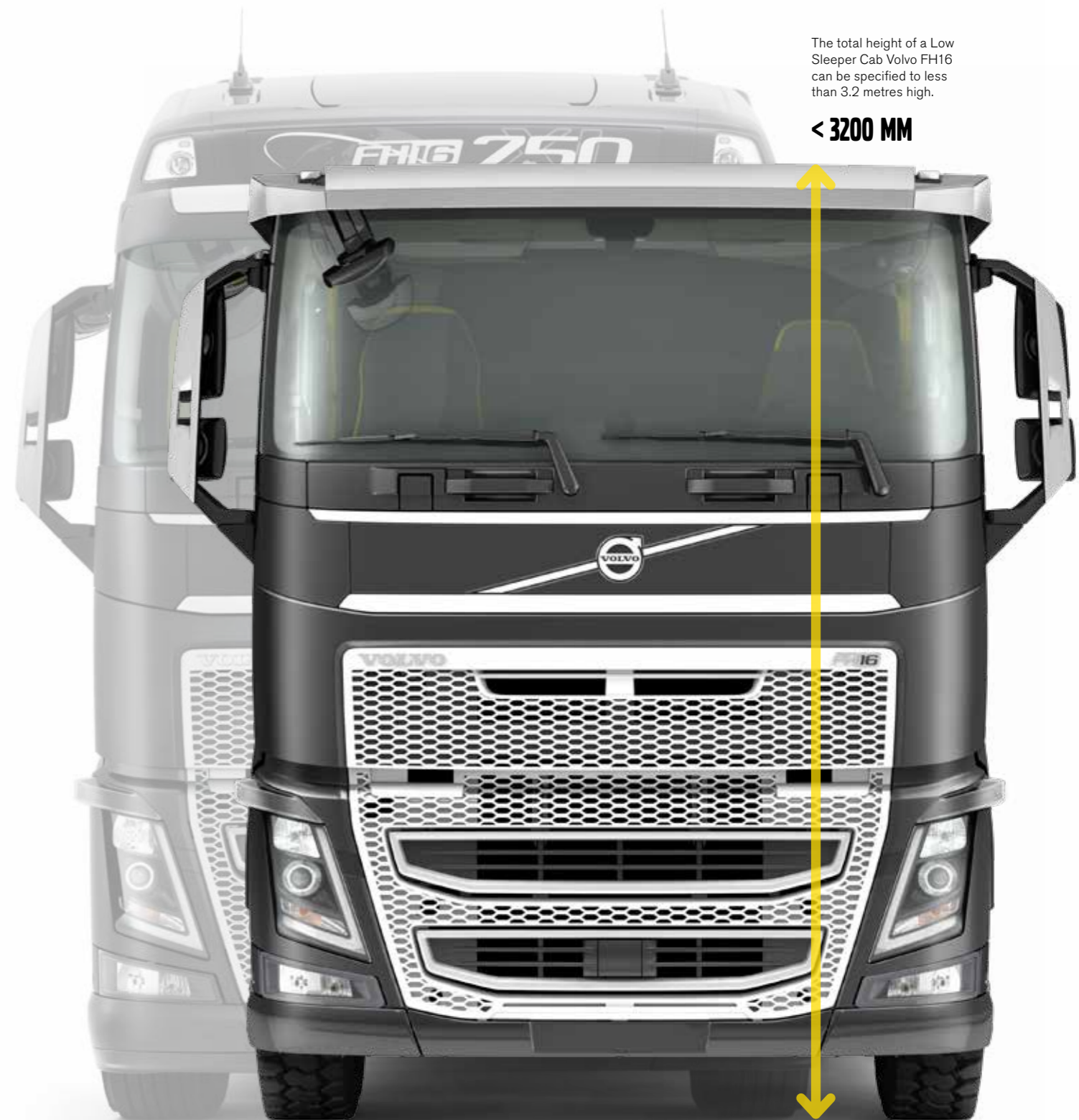

# Prepared to fit your body.

Bodybuilders tend to have a favourite truck and that is Volvo. That's because we've gone great lengths to make things easy for them by preparing the chassis for the superstructure already at the factory. They can avoid unnecessary and costly reconstruction work and that means a shorter stay at the bodybuilder's. Here are some of the features that will make a difference.



**Volvo Bodybuilder Instructions.**

As soon as you order your Volvo FH16, exact drawings of your very truck are available in the intuitive VBI online portal. The body-builder can start working while we build the truck, which dramatically shortens lead-times.



**Power take-offs for every need.**

There's a vast array of PTOs: Engine mounted as well as gearbox mounted, including both clutch-independent and clutch-dependent power take-offs. There is also a wide range of hydraulic pumps even with clutch to save fuel.



**The frame is straight.**

Unlike most other trucks, a Volvo features a frame that is completely straight and parallel behind the cab. This makes the bodybuilder's job a whole lot easier.



**Staying out of the bodybuilder's way.**

We never allow our engineers to place anything above the top of the frame. This area belongs entirely to the bodybuilder – adding a lot of flexibility.



**Loads of specification options.**

The more possible combinations, the easier a truck is to tailor. That's why the Volvo FH16 has more options than ever before when it comes to axle configurations, chassis heights and wheelbases.



**A dedicated row of holes.**

The frame comes with an upper row of holes that is designated for the superstructure. Since we don't use any rivets here, the body-builder can easily attach the equipment.

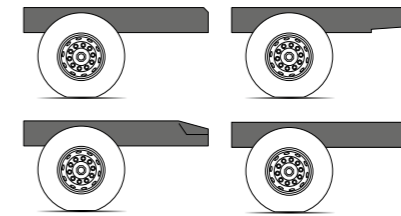

**4 different rear end cuts.**

We can deliver your FH16 from factory with four different rear frame-end cuts: upper (for tippers, hook-lifts and refuse trucks), lower (for centre-axle trailers), bent (for tractors) or straight (for rigid).

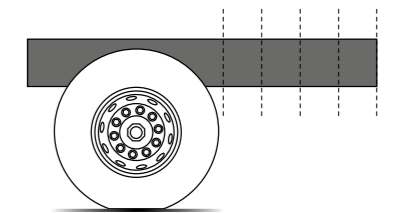

**Choose your exact rear overhang.**

The rear frame can be factory cut exactly as you need it – in 50 mm increments – to perfectly match your superstructure. Regardless of whether you are in need of an extremely short rear overhang or a longer one.



**Rear underrun position.**

To widen the rear end options even further, the rear underrun protection can be placed in several different positions.



**Two different frame heights.**

Choose between a 266 mm and a 300 mm frame depending on the demands of the superstructure.



**Body Builder Module.**

Makes it easy for the bodybuilder to tap into the truck's electrical system to tailor functions. You can access them conveniently on the flexible dashboard switches and in the Work Remote. 



**Perfect for swap bodies.**

Not all truck bodies are permanent. The 295 mm stroke of the rear air suspension in combination with the extra low chassis is the perfect solution if you transport temporary ones.



**Attachment brackets.**

Volvo FH16 can be factory prepared with body attachment brackets, mounted on the frame. Now available not only in the wheelbase area, but also on the rear overhang.



**Prepared for a crane.**

A low chassis and high axle loads. That is what's on every crane builders wishlist. Volvo FH16 comes with both. What's more, we can create a free frame space near the cab, and even deliver your truck with factory-mounted crane plates.

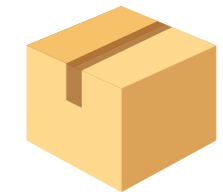

**Rigid chassis package.**

Options like side underrun protection, body-builder attachments, mudguards and LED tail lights are available in a convenient package – easy to order and with high quality.

**THE FUEL DEAL**

# Every drop counts.

Cutting fuel costs and emissions should be easy. That's why we've bundled our most efficient fuel-saving options into two packages. One of them adds features to the truck itself. The other is a collection of several useful services. If you sign up for both, you can count on reducing your fuel consumption by up to a full 11%. You can of course also get the two separately, or just pick the features you like.



**Dynafleet app.**

Want to see how fuel-efficient you were on your last shift? All you need is Dynafleet and a smartphone or a tablet. Just download the app, and you've got yourself a great way to improve your skills. Or maybe challenge your colleagues.

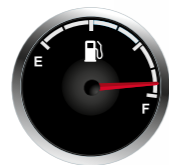

**More room for fuel.**

Speaking of fuel. The flexible chassis layout of Volvo FH16 allows you to optimise your truck for the fuel capacity you need. With a vast range of tanks, where the largest single tank is 900 litres and AdBlue tank volumes up to 100 litres, there's a good chance you can tailor your truck to carry the maximum amount of fuel allowed.

**DYNAFLEET FUEL & ENVIRONMENT**  
Volvo's fleet management system lets you monitor fuel consumption in real time from the office through an intuitive web interface. Analyse trends and find out where there's room for improvement, guided by built-in reports on driver behaviour, fuel and environmental impact.

**DRIVER TRAINING EFFICIENT DRIVING**  
Skilled drivers have an enormous impact on fuel-efficiency. Efficient Driving is the course where we focus on how to drive smartly and save fuel.



**24 V 150 A ALTERNATOR. MORE POWER FOR LESS FUEL.**  
A very energy-efficient alternator, needing less fuel to charge the batteries. Especially valuable if you consume a lot of power, for example when you're spending the nights in the cab.

**I-SEE.\* THE FARSIGHTED CO-PILOT.**  
I-See memorises all travelled roads in a data base. I-See can download the data, making it possible to control gearshifts and speed to make maximum use of the truck's momentum, leading to substantial fuel-savings. Read more about I-See on [page 20](#).



**ENGINE IDLE SHUTDOWN. SAVE FUEL WHILE STANDING STILL.**  
A smart feature that lets you save fuel by automatically turning the engine off after two and a half minutes of idling.

**CLUTCHABLE AIR COMPRESSOR. NO UNNECESSARY PRESSURE.**  
The air compressor is automatically declutched when not needed, leading to lower fuel consumption.

# Stay on the road by staying online.



### **Volvo Gold Contract.** The all-inclusive uptime package.

To keep your truck on the road making money, there's the Volvo Gold Contract – an off-the-shelf service package. It includes service and repairs. It includes preventive maintenance. And it includes Service Planning and Features Online, two truly ground-breaking service features made possible by the TGW (Telematics Gateway).

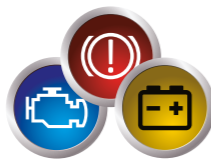

### **Service Planning.** One step ahead.

Thanks to the Telematics Gateway, the workshop can access information such as engine data, mileage, fuel consumption, diagnostic trouble codes, driving conditions and status of crucial components (brake pads, clutch, battery, air dryer etc.). That means we can alert you in time, before you risk an unplanned stop. But most importantly, we're always perfectly prepared when you enter the workshop. So you'll be back on the road before you know it.



### **Features Online.** Your wireless technician.

Some things shouldn't require a workshop visit. And now they don't. With Features Online, a service technician can access your vehicle remotely to calibrate displayed fuel consumption, fuel tank size (if you've fitted extra tanks) and your preferred road speed limit. It's even possible to enable the load indicator function from a distance. All you have to do is stop at the roadside for a short while. Service has never been quicker.



### **Need help?** Just push the button.

An unplanned stop out in the middle of nowhere? Volvo Action Service with On Call is just a button push away. It automatically connects you to an operator who speaks your language (the truck checks the nationality of the card in the digital tachograph). Once connected, service is both fast and accurate, because they already know your chassis ID, position and possible diagnostic trouble codes.

## HEADLIGHTS

# The future ahead looks bright.

# So do the curves and corners.

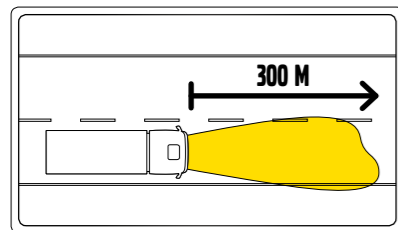

### Leading main beam.

When driving at night, Volvo FH16 is a particularly good friend. The headlights produce a powerful beam, providing you with an early view on what happens down the road. And, just as important, other road users will see you stand out in the dark.

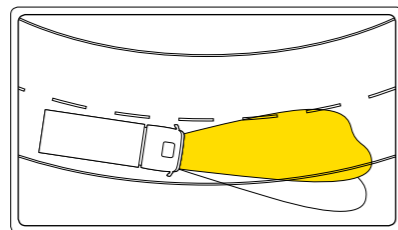

### Dynamic headlights.

With dynamic headlights, the dipped beam can pan to follow the road. Whenever you make a curve, so do the lights. On many stretches, this leads to a massively increased field of vision.

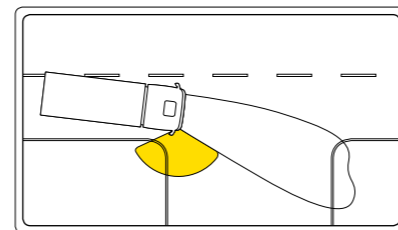

### Static cornering lights.

When you slow down to turn a corner in the dark, the enhanced static cornering lights come to your assistance. As soon as you activate the turn signal, the immediate area on the side lights up, helping you spot unprotected road users.

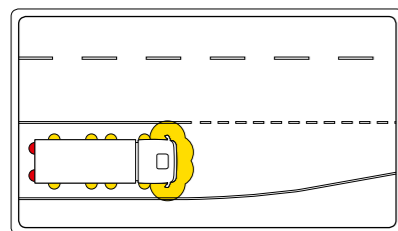

### Approach light.

When approaching the truck at night, just push the button on the remote key fob. The interior and exterior light up, letting you easily find and safely enter your truck. 



### Characteristic look.

The V shaped position and daytime running lights gives the Volvo FH16 an impression that's easy to catch from a distance.



### Bi-Xenon.

Equip the headlamps with Bi-Xenon to experience a new level of brightness. They also offer longer service life compared with regular halogen lamps.

SIDE TURN INDICATOR

MAIN BEAM

DIPPED BEAM

TURN INDICATOR

POSITION LIGHT AND DAYTIME RUNNING LIGHT 

AUXILIARY LAMPS

Room for fog lights, along with static cornering lights or extra spotlights. 

# Keeping an extra eye on the road.

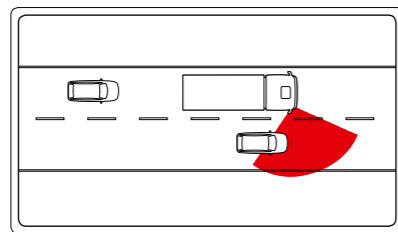

**Cornering camera.**

Keep an eye on the hidden area on the passenger side of the truck. The cornering camera is activated when using the side turn indicator and displays the side view in the Secondary Information Display.

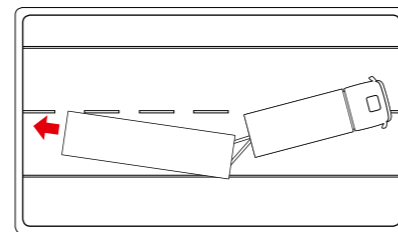

**Stretch Brake.**

In certain situations, such as turning or driving downhill on a slippery road, the trailer risks catching up with the truck, creating a hazardous jack-knife effect. The Stretch Brake is a Volvo feature, designed to stop that from happening. By pulse braking the trailer, the vehicle combination is stretched, and the danger reduced. The system can be automatically activated in risky situations, at speeds up to 50 km/h.

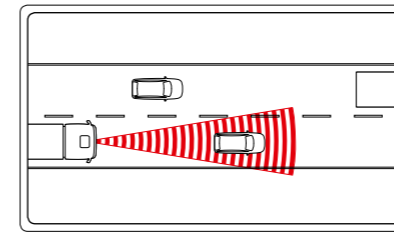

**Adaptive Cruise Control, collision warning and emergency brake.**

Follow the traffic rhythm without effort. The radar-based Adaptive Cruise Control (ACC) keeps a safe distance to the vehicle in front by controlling the accelerator and all available brakes. If there's a risk of collision, warning lights are projected on the windscreen – and if an impact is imminent, the automatic emergency brake quickly comes to your assistance.

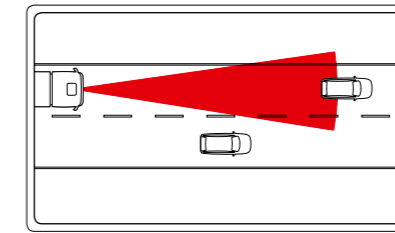

**Lane Keeping Support.**

Drifting off lane is a common cause of serious accidents. Too common, we think. Lane Keeping Support tracks the road markings with a camera, and alerts you if you should unintentionally cross them.

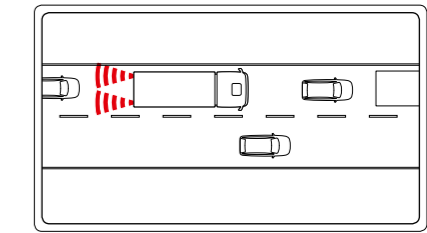

**Emergency brake light.**

If you slam on the brakes, the brake lights flashes rapidly to alert the vehicles behind you. An easy way of avoiding rear-end collisions, which can be fatal and lead to major pile-ups. 🚚

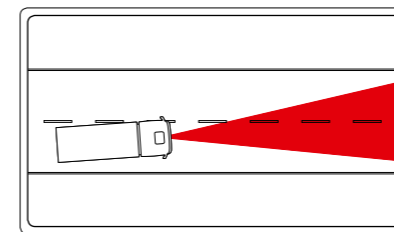

**Driver Alert Support.**

Driver Alert Support is an intelligent system that tracks your driving behaviour. If it differs from normal and indicates tiredness, you are alerted by a signal and a message in the display, advising you to take a break. 🚚

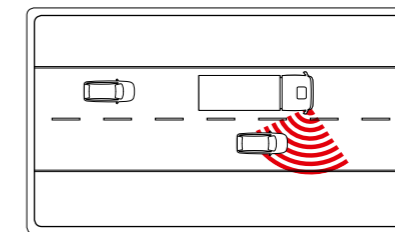

**Lane Changing Support.**

The blind-spot area on the passenger side can easily hide other road users. Lane Changing Support is equipped with a radar that checks that area when you activate the turn signal. If the area's not clear, you are notified by a sound and a flashing icon by the mirror.

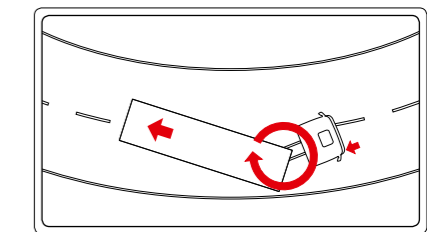

**Electronic Stability Program.**

Volvo's Electronic Stability Program (ESP) efficiently reduces the risk of skidding and rollovers. In risky situations it instantly steps in, reducing engine power and braking the truck and trailer. Each wheel of the truck is braked individually. ESP is now available for most truck specifications, both tractors and rigs. 🚚

🚚 Also available as an accessory.



## SPECIFICATIONS

# Tailoring your Volvo FH16.

This is just a hint of all the choices you have when tailoring your Volvo FH16 to your needs. The full specifications and all possible options are available at [www.volvotrucks.com](http://www.volvotrucks.com) or at your Volvo dealer.

### Cabs

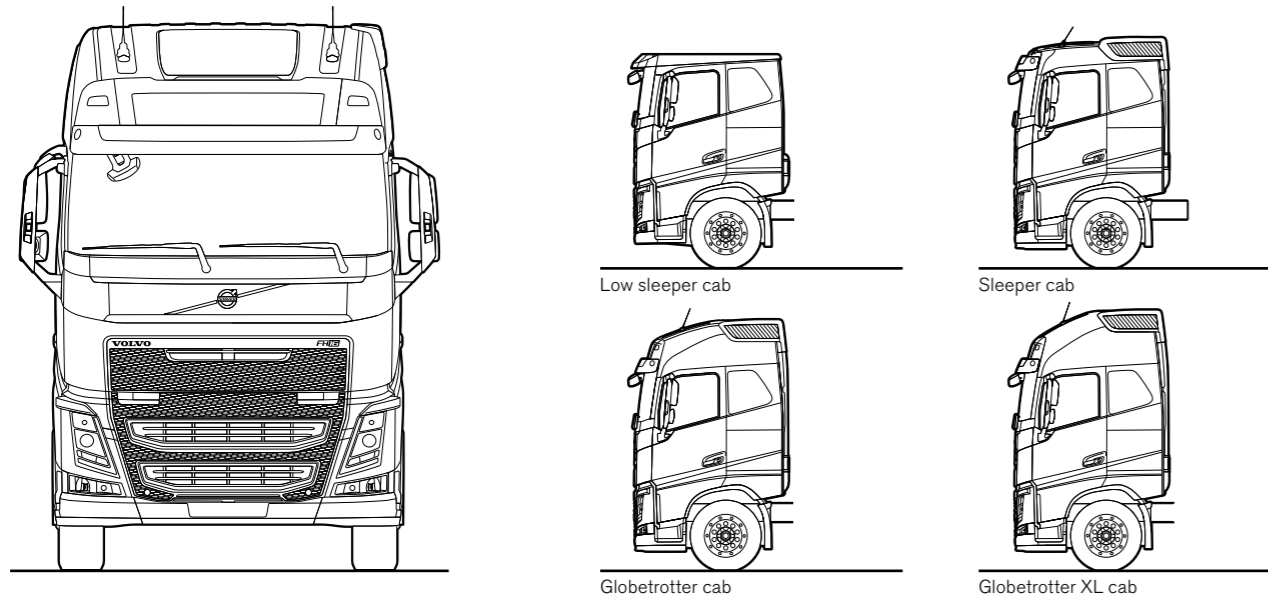

### Tractor axle configurations



### Rigid axle configurations

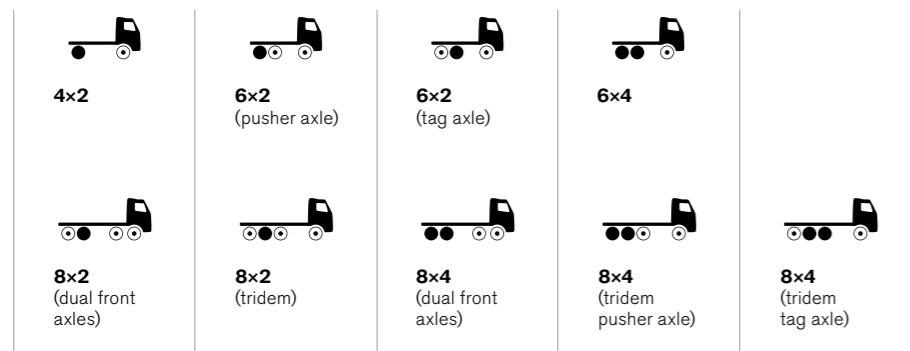

● = Drive axle.  
○ = Dead axle (tag, pusher or front axle).

### Engines

16 LITRE	Max power	Max torque
<b>EURO 3</b>		
D16C550 (405 kW)	550 hp at 1600–1700 r/min	2500 Nm at 1000–1500 r/min
D16C610 (449 kW)	610 hp at 1600–1700 r/min	2800 Nm at 1000–1500 r/min
<b>EURO 4</b>		
D16E540 (397 kW)	540 hp at 1450–1800 r/min	2600 Nm at 1000–1450 r/min
D16E600 (441 kW)	600 hp at 1500–1900 r/min	2800 Nm at 1000–1500 r/min
D16E700 (515 kW)	700 hp at 1550–1800 r/min	3150 Nm at 1000–1550 r/min
<b>EURO 5</b>		
D16G540 (397 kW)	540 hp at 1450–1900 r/min	2650 Nm at 1000–1450 r/min
D16G600 (441 kW)	600 hp at 1500–1900 r/min	2800 Nm at 1000–1500 r/min
D16G700 (515 kW)	700 hp at 1550–1800 r/min	3150 Nm at 1000–1550 r/min
D16G750 (551 kW)	750 hp at 1600–1800 r/min	3550 Nm at 1050–1400 r/min

### Gearboxes

#### I-SHIFT

12-speed splitter and range gearbox with automated gearchanging system. The version with crawler gears facilitates easy operation with GCW up to 325 tonnes.

Type	Top gear	Engine torque (Nm)	GCW approval (tonnes)
AT2812F	Direct	2800	44/52
ATO3112F	Overdrive	3100	100
ATO3512F	Overdrive	3550	60

#### MANUAL GEARBOXES

14-speed splitter and range manual gearbox with two crawler gears. Short and distinct gear settings with low gearchanging forces.

Type	Top gear	Engine torque (Nm)	GCW approval (tonnes)
VT2814B	Direct	2800	100
VTO2814B	Direct	2800	100

Here's a small selection of specifications – but there are more to choose from. Ask your Volvo dealer or visit [www.volvotrucks.com](http://www.volvotrucks.com) to learn more.

## ACCESSORIES

# Make it your truck.

The Volvo FH16 is one of the most well equipped trucks in the world. But to tailor it for your particular transport assignments and for your personal needs, there's also a wide range of accessories to choose from. It's all about making the truck more efficient for the work you do. And don't forget that they are all developed and tested by Volvo Trucks for Volvo trucks to make sure they all bring what you expect from a Volvo product. Hey, we've even crash tested the coffee maker!

Here's a small selection of accessories – but there are tonnes more to choose from. Ask your Volvo dealer or visit [www.volvotrucks.com](http://www.volvotrucks.com) to learn more about accessories.



Lower light bar



Stainless steel wheel cover



Flashing LED warning light



Air blow gun



Alcolock



Coffee maker



Exterior water tank



Red seat belt



Cradle plate for phone

Some of the equipment shown or mentioned may only be available as options or accessories and may vary from one country to another in accordance with local legislation. Your Volvo dealer will be happy to provide you with more detailed information. Colours may vary somewhat owing to the limitations of the printing process. We reserve the right to alter product specifications without prior notification.



**VOLVO**

Volvo Truck Corporation  
[volvotrucks.com](http://volvotrucks.com)